

NEW

Front Loaders

L SERIES



Landini

FRONT LOADERS



USE	2
DESIGN	3
7 160-180-200-220-230 (6 Cylinders) SERIES	4
7 145-165-175 (4 Cylinders) SERIES	5
6C 125-135-145 SERIES	6
6H 115-125-135 SERIES	7
5 100-110-120 SERIES	8
4 70-80-90-95-100-110 SERIES	9
4D 70-80-90 SERIES	10
REX4 F,GE,GB,GT. 70-80-90-100-110-120	11
REX4 V 70-80-90-100-110	12
2 45-50-55 SERIES	13
IMPLEMENTS	14

L Series front loaders: the perfect match for Landini tractors.

The growing use of front loaders for a variety of applications has led Landini to expand its product line with the addition of a front loader range.

Landini front loaders are factory fitted on the **4, 5, 6H, 6C and 7** tractor series. For all the other models, they can be purchased as aftermarket equipment from Argo Tractors Spare Parts

Division. The L Series front loader range includes four models – **L60B/C, L80B/C/P, L100B/C/P** and **L120C/P** – with lift heights at pivot ranging from 3.45 to 4.15 m and lift capacities at 2m lift height ranging between 1200 and 2400 kg. (Lift capacity is measured at 180 bar working pressure at base of implement 900 mm ahead of pivot).

Landini front loaders are designed with strength, safety and comfort in mind. The boom is built with high-strength steel rectangular hollow sections designed to provide superior torsional and bending strength.

The front loader also features a twin-accumulator suspension system (single-accumulator for L60B / L80B / L100B models) which absorbs impacts on rough terrain. This improves ride comfort and makes for more efficient handling of bulk goods, while minimising power loss at constant speed.

Landini front loader range is complemented by a wide choice of implements which can be ordered from Argo Tractors Parts Division.

Implement range includes general purpose buckets, light material buckets, manure forks, round bale spikes, pallet forks and combi forks. All these implements will enable the user to perform a variety of transport and handling operations, road maintenance activities and any other tasks requiring a front loader.



EASE OF USE AND QUICK LOADER MOUNTING AND DISMOUNTING

Specially designed to suit the Landini tractor range, L Series front loaders are extremely rugged and versatile. The front loader is comfortably operated from the tractor cab via a multi-function joystick. The tractor cab is also equipped with a transparent roof

hatch for extra visibility during loader operations. An exclusive connect/disconnect system enables the operator to remove the loader from the tractor in a few minutes. The Euro implement holder also makes it easy and quick to mount and dismount implements.



Front loader unlock lever

Two unlocking handles make it easy to connect and disconnect the loader from the tractor frame.



Front loader mounting frame

The loader mounting frame is specially designed to perfectly fit Landini tractors, making mounting and removing the loader quick and easy. It also ensures unobstructed forward view and provides best access to engine maintenance points even when the front loader is fitted.



Quick-connect multi-coupler for tractor/loader hydraulic connection

The hydraulic connection between tractor and loader is made via quick-connect multicoupler which makes loader removal easy and quick.



Front loader removal and parking

To remove loader from tractor, lower implement until it rests on the ground, lower parking stands, then disengage loader and disconnect hydraulic hoses. Lastly, slowly back tractor away from loader.

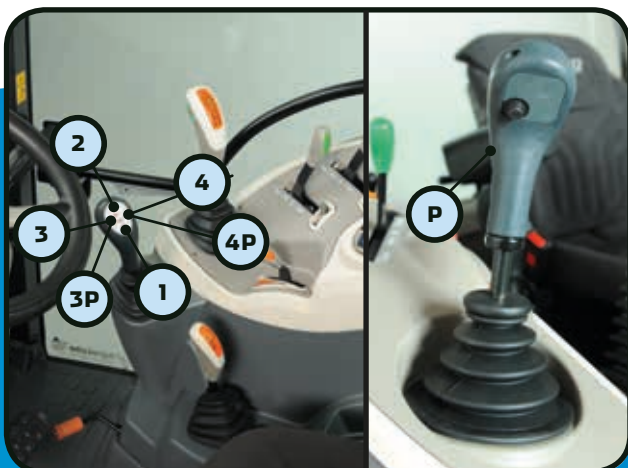

The loader joystick is located on the driver's right-hand side.

The joystick provides six main functions for operation of front loader and implements:

- Joystick pos. 1: Boom lowering.
 - Joystick pos. 2: Boom raising.
 - Joystick pos. 3: Implement rollback.
 - Joystick pos. 4: Implement dumping.
- Position 3 and 4 are activated by pressing the electrohydraulic pushbutton control (P) integrated into the joystick.

This enables implements with additional hydraulic functions, such as wrapped round bale clammers or manure forks with grapple, to be operated via a solenoid valve fitted on the loader front. The P pushbutton will enable operator to switch from the implement rollback and dumping positions 3 and 4 to the additional hydraulic functions (pos. 3P and 4P).

The joystick is also equipped with a sliding ring which locks out all functions for increased safety

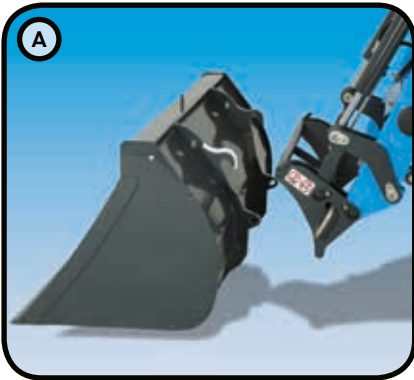

Landini front loaders are equipped with Euro implement holder enabling the use of a wide range of implements (fig. A).



A two-port solenoid valve can be optionally mounted to the loader front frame to operate cylinders on implements with additional hydraulic functions (fig. B).

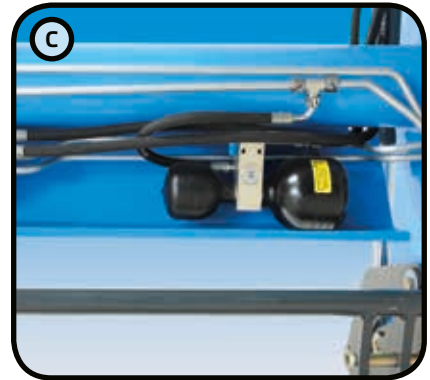

The lift cylinders are equipped with two nitrogen accumulators to cushion loader oscillations arising during the ride. This results in smoother operation and enhanced driving comfort (fig. C).

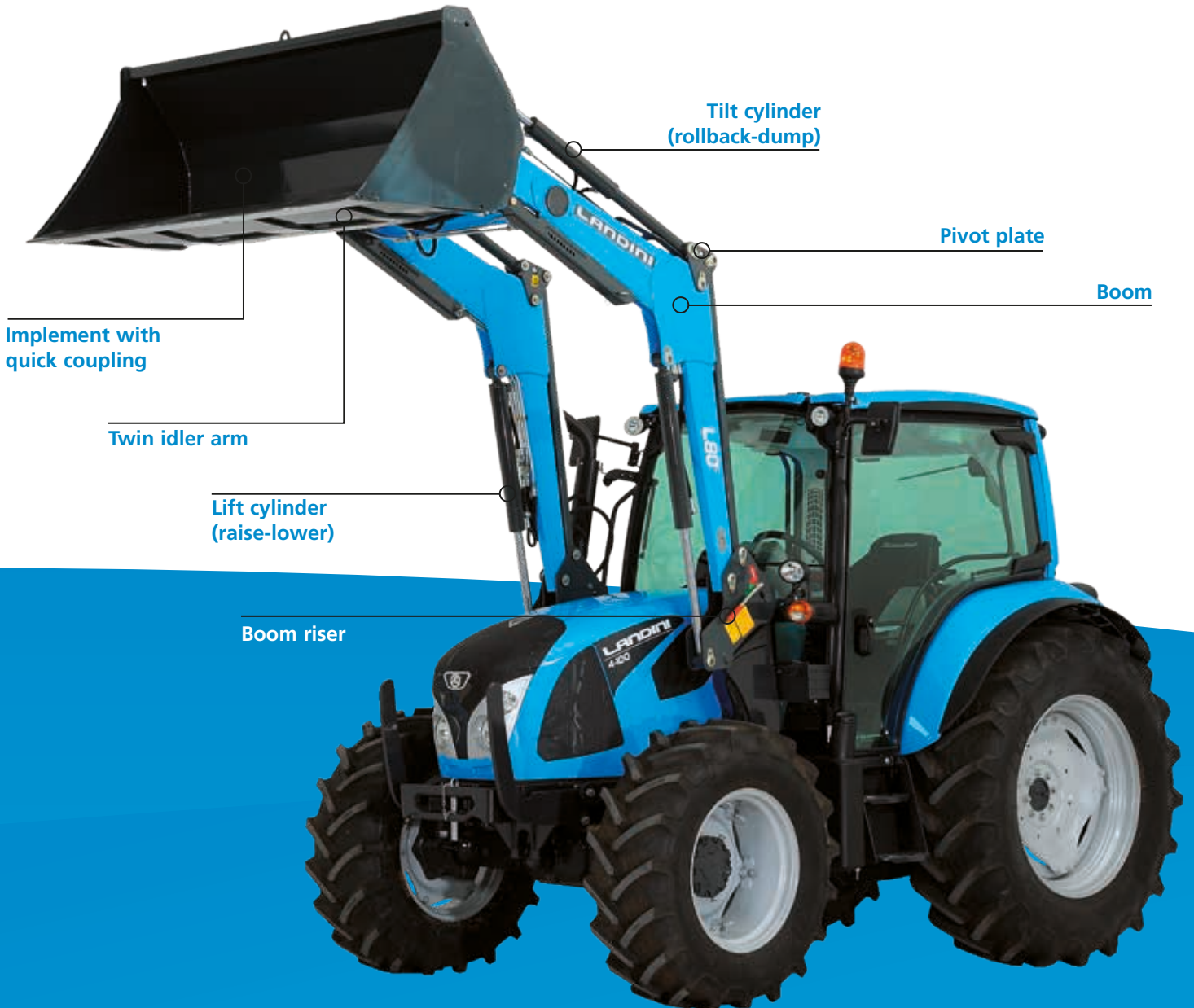

Tilt cylinder (rollback-dump)

Pivot plate

Boom

Implement with quick coupling

Twin idler arm

Lift cylinder (raise-lower)

Boom riser

7 Series (6 Cylinders)

Model	160	180	200	220	230
Front Loader	L140P	L140P	L180P	L180P	L180P



Specifications

MODEL	160-180	200-220-230
FRONT LOADER	L140P	L180P
Tractor power hp	120-180	+ 150
Lift capacity at pivot * m	4.27	4.50
Lift capacity of pallet fork at ground level kg ⁽¹⁾	2910	2900
Lift capacity of pallet fork at 2m lift height kg ⁽¹⁾	2545	2560
Lift capacity of pallet fork at maximum height kg ⁽¹⁾	2125	2300
Digging angle (at ground level)*	49°	48°
Dump angle (at full height) *	54°	63°
Lift cylinder OD (Ø mm)	Ø 80	Ø 90
Mechanical self-levelling	Yes	Yes
Euro implement holder	Yes	Yes
Distance between boom arms mm	1020	1120
Mounting frame type	Mega Matic	Mega Matic HD
Implement holder pre-equipped for Manip'Pic	-	-
Boom weight without options kg	820	990

*Features may vary according to tractor model - ⁽¹⁾180 bar control pressure at 60 l/min flow rate, measured 900 mm ahead of pivot.



7 Series (4 Cylinders)

Model	145	165	175
Front Loader	L120C	L120P	L140P



Specifications

MODEL	145 - 165		175
	L120 ^C	L120 ^P	L140 ^P
Tractor power hp	95-140	95-160	120-180
Lift capacity at pivot * m	4,13	4,15	4,27
Lift capacity of pallet fork at ground level kg ⁽¹⁾	2450	2510	2910
Lift capacity of pallet fork at 2m lift height kg ⁽¹⁾	2280	2400	2545
Lift capacity of pallet fork at maximum height kg ⁽¹⁾	2030	2160	2125
Digging angle (at ground level)*	51°	52°	49°
Dump angle (at full height) *	54°	55°	54°
Lift cylinder OD (Ø mm)	Ø80		
Mechanical self-levelling	Yes		
Euro implement holder	Yes		
Distance between boom arms mm	1020		
Mounting frame type	MM		
Implement holder pre-equipped for Manip'Pic	Optional		-
Boom weight without options kg	640	700	820

*Features may vary according to tractor model - ⁽¹⁾180 bar control pressure at 60 l/min flow rate, measured 900 mm ahead of pivot.

6c Series

Model	125	135	145
Front Loader	L80B/C/P	L80/L100B/C/P	L120C/P



Specifications

MODEL	125-135			135			145	
	L80 ^a	L80 ^c	L80 ^p	L100 ^a	L100 ^c	L100 ^p	L120 ^c	L120 ^p
Tractor power hp	60 - 110	60-110	60-110	70 - 120	70-120	70-120	95-140	95-160
Lift capacity at pivot * m	3,80	3,77	3,80	4,00	3,92	4,00	4,13	4,15
Lift capacity of pallet fork at ground level kg ⁽¹⁾	1600	1800	2100	1800	2350	2440	2450	2510
Lift capacity of pallet fork at 2m lift height kg ⁽¹⁾	1650	1430	1810	1850	1960	2160	2280	2400
Lift capacity of pallet fork at maximum height kg ⁽¹⁾	1500	1100	1420	1700	1500	1880	2030	2160
Digging angle (at ground level)*	45°	49°	49°	49°	49°	51°	51°	52°
Dump angle (at full height) *	59°	53°	56°	59°	55°	54°	54°	55°
Lift cylinder OD (Ø mm)	Ø70	Ø70	Ø75	Ø75	Ø75	Ø80	Ø80	Ø80
Mechanical self-levelling	Yes							
Euro implement holder	Yes							
Distance between boom arms mm	1020							
Mounting frame type	Méga Maticw							
Implement holder pre-equipped for Manip'Pic	Optional							
Boom weight without options kg	435	500	640	460	570	670	640	700

*Features may vary according to tractor model - ⁽¹⁾180 bar control pressure at 60 l/min flow rate, measured 900 mm ahead of pivot.

6H Series



Model	115	125	135
Front Loader	L80B/C/P	L80/M100B/C/P	L100B/C/P



Specifications

MODEL	115-125			125-135		
	L80 ^a	L80 ^c	L80 ^p	L100 ^b	L100 ^c	L100 ^p
Tractor power hp	60 - 110	60-110	60-110	70-120	70-120	70-120
Lift capacity at pivot * m	3,80	3,77	3,80	4,00	3,92	4,00
Lift capacity of pallet fork at ground level kg ⁽¹⁾	1600	1800	2100	1800	2350	2440
Lift capacity of pallet fork at 2m lift height kg ⁽¹⁾	1650	1430	1810	1850	1960	2160
Lift capacity of pallet fork at maximum height kg ⁽¹⁾	1500	1100	1420	1700	1500	1880
Digging angle (at ground level)*	45°	49°	49°	49°	49°	51°
Dump angle (at full height) *	59°	53°	56°	59°	55°	54°
Lift cylinder OD (Ø mm)	Ø 70	Ø 70	Ø 75	Ø75	Ø 75	Ø 80
Mechanical self-levelling	Yes			Yes		
Euro implement holder	Yes			Yes		
Distance between boom arms mm	1020			1020		
Mounting frame type	Méga Matic			Méga Matic		
Implement holder pre-equipped for Manip'Pic	Optional	Optional	Optional	Optional	Optional	Optional
Boom weight without options kg	435	500	640	460	570	670

*Features may vary according to tractor model - ⁽¹⁾180 bar control pressure at 60 l/min flow rate, measured 900 mm ahead of pivot.

5 Series

Model	100	110	120
Front Loader	L80B/C/P	L80B/C/P	L80B/C/P



Specifications

MODEL	100-110-120		
FRONT LOADER	L80 ^B	L80 ^C	L80 ^P
Tractor power hp	60 - 110	60-110	60-110
Lift capacity at pivot * m	3,80	3,77	3,80
Lift capacity of pallet fork at ground level kg ⁽¹⁾	1600	1800	2100
Lift capacity of pallet fork at 2m lift height kg ⁽¹⁾	1650	1430	1810
Lift capacity of pallet fork at maximum height kg ⁽¹⁾	1500	1100	1420
Digging angle (at ground level)*	45°	49°	49°
Dump angle (at full height) *	59°	53°	56°
Lift cylinder OD (Ø mm)	Ø70	Ø70	Ø75
Mechanical self-levelling	Yes		
Euro implement holder	Yes		
Distance between boom arms mm	1020		
Mounting frame type	Méga Matic		
Implement holder pre-equipped for Manip'Pic	Optional	Optional	
Boom weight without options kg	435	500	640

*Features may vary according to tractor model - ⁽¹⁾180 bar control pressure at 60 l/min flow rate, measured 900 mm ahead of pivot.

4 Series



Model	70	80	90	95	100	110
Front Loader	L60B/C	L60B/C	L60B/C	L60B/C	L60B/C	L60B/C
Front Loader				L80B/C/P	L80B/C/P	L80B/C/P

Specifications

MODEL	70-80-90		95-100-110		
	L60 ^B	L60 ^C	L80 ^B	L80 ^C	L80 ^P
Tractor power hp	50 - 100	50-100	60 - 110	60-110	60-110
Lift capacity at pivot * m	3,50	3,45	3,80	3,77	3,80
Lift capacity of pallet fork at ground level kg ⁽¹⁾	1380	1770	1600	1800	2100
Lift capacity of pallet fork at 2m lift height kg ⁽¹⁾	1400	1240	1650	1430	1810
Lift capacity of pallet fork at maximum height kg ⁽¹⁾	1300	1000	1500	1100	1420
Digging angle (at ground level)*	44°	44°	45°	49°	49°
Dump angle (at full height) *	59°	57,5°	59°	53°	56°
Lift cylinder OD (Ø mm)	Ø65		Ø70		Ø75
Mechanical self-levelling	Yes				
Euro implement holder	Yes				
Distance between boom arms mm	1020				
Mounting frame type	Méga Matic				
Implement holder pre-equipped for Manip'Pic	Optional				
Boom weight without options kg	400	430	435	500	640

*Features may vary according to tractor model - ⁽¹⁾180 bar control pressure at 60 l/min flow rate, measured 900 mm ahead of pivot.

4D Series

Model	70	80	90
Front Loader	L60B/C	L60B/C	L60B/C



Specifications

MODEL	70-80-90	
FRONT LOADER	L60 ^B	L60 ^C
Tractor power hp	50 - 100	50-100
Lift capacity at pivot * m	3,50	3,45
Lift capacity of pallet fork at ground level kg ⁽¹⁾	1380	1770
Lift capacity of pallet fork at 2m lift height kg ⁽¹⁾	1400	1240
Lift capacity of pallet fork at maximum height kg ⁽¹⁾	1300	1000
Digging angle (at ground level)*	44°	44°
Dump angle (at full height) *	59°	57,5°
Lift cylinder OD (Ø mm)	Ø65	Ø65
Mechanical self-levelling	Yes	
Euro implement holder	Yes	
Distance between boom arms mm	1020	
Mounting frame type	Méga Matic	
Implement holder pre-equipped for Manip'Pic	Optional	
Boom weight without options kg	400	430

*Features may vary according to tractor model - ⁽¹⁾180 bar control pressure at 60 l/min flow rate, measured 900 mm ahead of pivot.

REX4 Series

F GE GB GT

Modello	70	80	90	100	110	120
Caricatore	L40NB/N	L40NB/N	L40NB/N	L40NB/N	L40NB/N	L40NB/N
Caricatore	L50NB/N	L50NB/N	L50NB/N	L50NB/N	L50NB/N	L50NB/N



Specifications

MODEL	70-80-90-100-110-120-F-GE-GB-GT			
FRONT LOADER	L40 ^{NB}	L40 ^N	L50 ^{NB}	L50 ^N
Tractor power hp	40 - 90		50 - 115	
Lift capacity at pivot * m	2,80	2,85	3,45	3,45
Lift capacity of pallet fork at ground level kg ⁽¹⁾	1080	1185	1150	1225
Lift capacity of pallet fork at 2m lift height kg ⁽¹⁾	1100	1070	1150	1200
Lift capacity of pallet fork at maximum height kg ⁽¹⁾	1025		1150	
Digging angle (at ground level)*	38°	45°	38°	45°
Dump angle (at full height) *	77°	57,5°	66°	57,5°
Lift cylinder OD (Ø mm)	Ø60			
Mechanical self-levelling	Yes			
Euro implement holder	Yes			
Distance between boom arms mm	940			
Mounting frame type	GM			
Implement holder pre-equipped for Manip'Pic	Optional			
Boom weight without options kg	330	340	340	380

*Features may vary according to tractor model - ⁽¹⁾180 bar control pressure at 60 l/min flow rate, measured 900 mm ahead of pivot.

REX4V Series

Model	70	80	90	100	110
Front Loader	L40NB/N	L40NB/N	L40NB/N	L40NB/N	L40NB/N
Front Loader	L50NB/N	L50NB/N	L50NB/N	L50NB/N	L50NB/N



Specifications

MODEL	70-80-90-100-110 V			
FRONT LOADER	L40 ^{NB}	L40 ^N	L50 ^{NB}	L50 ^N
Tractor power hp	40 - 90		50 - 115	
Lift capacity at pivot * m	2,80	2,85	3,45	3,45
Lift capacity of pallet fork at ground level kg ⁽¹⁾	1080	1185	1150	1225
Lift capacity of pallet fork at 2m lift height kg ⁽¹⁾	1100	1070	1150	1200
Lift capacity of pallet fork at maximum height kg ⁽¹⁾	1025		1150	
Digging angle (at ground level)*	38°	45°	38°	45°
Dump angle (at full height) *	77°	57,5°	66°	57,5°
Lift cylinder OD (Ø mm)	Ø60			
Mechanical self-levelling	Yes			
Euro implement holder	Yes			
Distance between boom arms mm	940			
Mounting frame type	GM			
Implement holder pre-equipped for Manip'Pic	Optional			
Boom weight without options kg	330	340	340	380

*Features may vary according to tractor model - ⁽¹⁾180 bar control pressure at 60 l/min flow rate, measured 900 mm ahead of pivot.

2 Series

STD GE



Model	45	50	55
Front Loader	LS25	LS25	LS25
Front Loader	LS25+	LS25+	LS25+
Front Loader	LC25	LC25	LC25



Specifications

MODEL	45-50-55		
	LS25	LS25+	LC25
Tractor power hp	20 - 50	20 - 50	20 - 50
Lift capacity at pivot * m	2.60	2.60	2.60
Lift capacity of pallet fork at ground level kg ⁽¹⁾	510	420	530
Lift capacity of pallet fork at 2m lift height kg ⁽¹⁾	500	430	530
Lift capacity of pallet fork at maximum height kg ⁽¹⁾	470	380	530
Digging angle (at ground level)*	25°	45°	46°
Dump angle (at full height) *	35°	50°	50°
Mechanical self-levelling	-	-	Yes
Implement holder with automatic latch system	-	Yes	Yes
Boom weight without options kg	220	220	240

*Features may vary according to tractor model - ⁽¹⁾180 bar control pressure at 60 l/min flow rate, measured 900 mm ahead of pivot.

STANDARD BUCKET

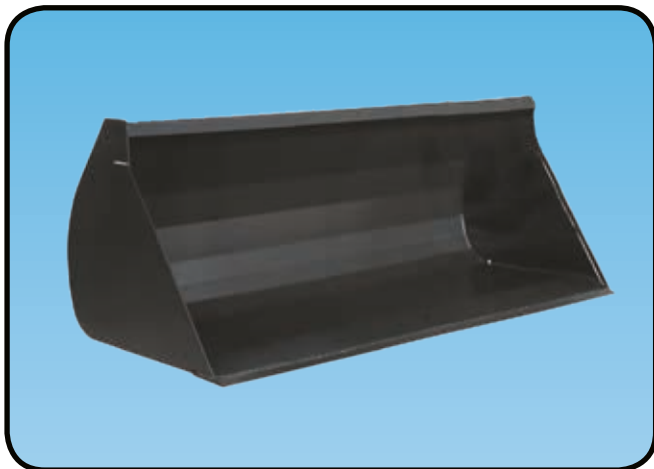

STANDARD BUCKET - Without teeth			
	WIDTH (M)	CAPACITY (L) ⁽¹⁾	WEIGHT (KG) ⁽²⁾
BP 180 ⁽²⁾	1,80	605/785	266
BP 200 ⁽²⁾	2,00	675/875	284
BP 225 ⁽²⁾	2,25	760/985	305
BP 245 ⁽²⁾	2,45	825/1070	322

⁽¹⁾ Actual capacity /Useful capacity. - ⁽²⁾ With wear strip 150x15 - ⁽³⁾ Approximate weight.

LIGHT MATERIAL BUCKET

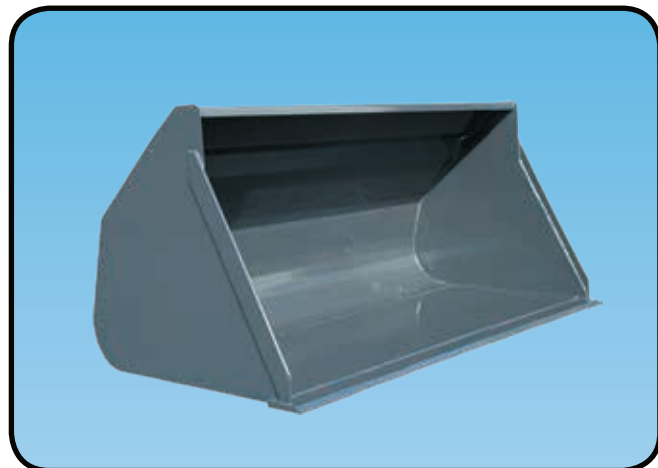

LIGHT MATERIAL BUCKET - High volume

	WIDTH (M)	CAPACITY (L) ⁽¹⁾	WEIGHT (KG) ⁽²⁾
BL 170 ^(2,4)	1,70	1035/1242	380
BL 200 ^(3,4)	2,00	1215/1458	410
BL 220 ^(3,4)	2,20	1340/1608	440
BP 240 ^(3,4)	2,40	1460/1752	470

⁽¹⁾ Actual capacity /Useful capacity. - ⁽²⁾ With wear strip 150x15. - ⁽³⁾ With wear strip 150x20. - ⁽⁴⁾ With wear strip. ⁽⁵⁾ Approximate weight.

MULTI-PURPOSE BUCKET AV



Multi-purpose bucket av - 3rd function required			
	WIDTH (M)	CAPACITY (L) ⁽¹⁾	WEIGHT (KG) ⁽²⁾
MBV140 - 5 TEETH	1,20 - 1,40	585	220
MBV150 - 6 TEETH	1,30 - 1,50	655	235
MBV170 - 7 TEETH	1,50 - 1,70	750	250
MBV190 - 8 TEETH	1,70 - 1,90	845	265
MBV220 - 9 TEETH	2,00 - 2,20	990	320

⁽²⁾ Approximate weight.

MANURE FORK

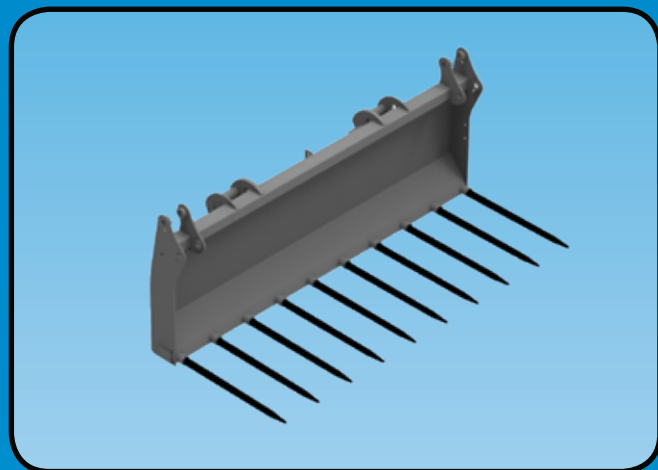

MANURE FORK - BOLTED TEETH - Length 0.82

	WIDTH (M)	N. TEETH	WEIGHT (KG) ⁽¹⁾
FF120	1,20	6	135
FF140	1,40	7	154
FF160	1,60	8	167
FF180	1,80	9	185
FF200	2,00	10	205
FF225	2,25	11	220

⁽¹⁾ Bolted teeth - L. 0,82 m. - ⁽²⁾ Removable teeth with bolts - L.g. 0,87 m. - ⁽³⁾ Approximate weight.

EARTH BUCKET

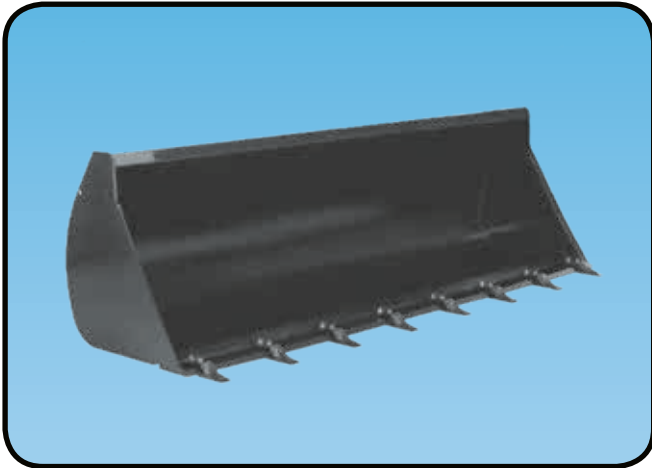

EARTH BUCKET - Removable teeth

	WIDTH (M)	CAPACITY (L) ⁽¹⁾	WEIGHT (KG) ⁽²⁾
BTB 130 - 5 TEETH	1,30	345/450	183
BTB 150 - 6 TEETH	1,50	400/515	200
BTB 180 - 7 TEETH	1,80	480/625	230
BTB 200 - 7 TEETH	2,00	535/695	245
BTB 225 - 8 TEETH	2,25	600/780	265

⁽¹⁾ Actual capacity /Useful capacity. - ⁽²⁾ Approximate weight.

MULTI-PURPOSE BUCKET

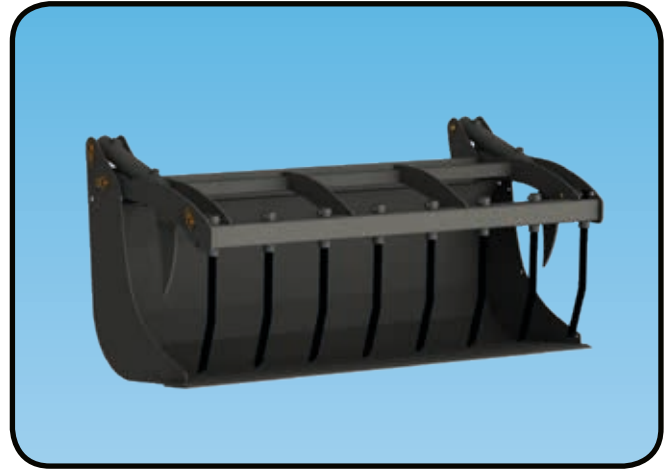

MULTI-PURPOSE BUCKET - 3rd function required

	WIDTH (M)	CAPACITY (L) ⁽¹⁾	WEIGHT (KG) ⁽²⁾
MB120 - 5 TEETH	1,20	560	215
MB130 - 6 TEETH	1,30	625	230
MB150 - 7 TEETH	1,50	725	245
MB170 - 8 TEETH	1,70	820	260
MB200 - 9 TEETH	2,00	965	315

⁽²⁾ Approximate weight.

PALLET FORK

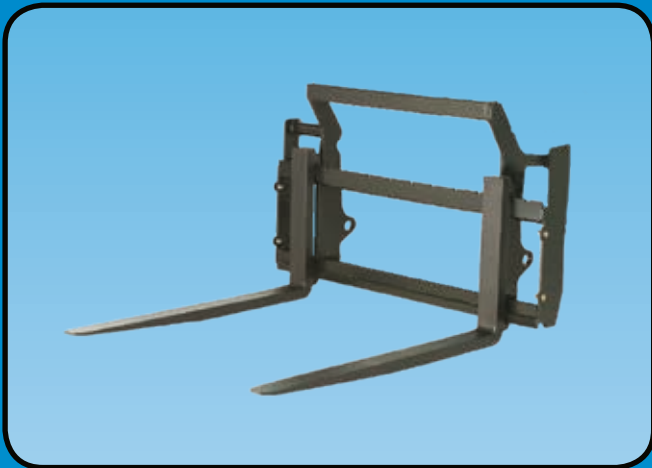

PALLET FORK - Forged forks

	CAPACITY (L) ⁽¹⁾	FORKS (MM)
TP1650	1650	1000 x 80 x 40
TP2500	2500	1200 x 100 x 45

Recommended for self-levelling front loaders.

MANIP' BAL BRE 4

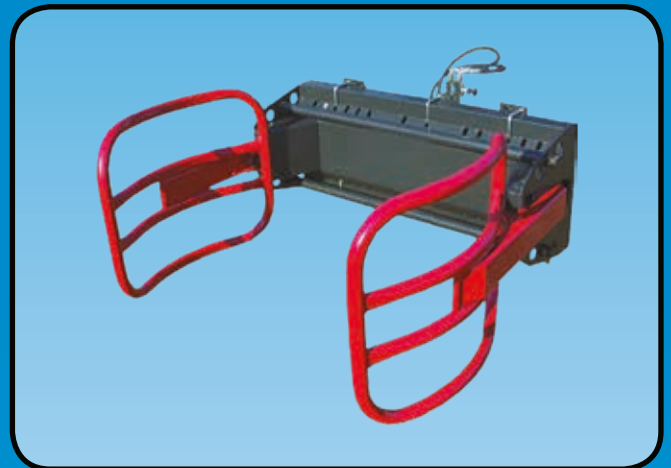

MANIP' BAL BRE 4 - Round bale clasper

	WEIGHT (KG) ⁽²⁾
BRE 4	245
BRE 4 - L	130

Wrapped round bales Ø 0.90 m to 1.75 m (Max. weight 1200 kg). Synchronisation spring on both arms to facilitate self-centring. Integrated check valve to hold bale in place. 3rd function required. ⁽²⁾ Approximate weight.

L SERIES FRONT LOADERS

L Series / L Standard

FRONT LOADER WITH SELF-LEVELLING SYSTEM – L SERIES	L60	L80	L100	L120
FRONT LOADER WITHOUT SELF-LEVELLING SYSTEM – L STANDARD	LS60	LS80	LS100	LS120

For tractors from 50 to 140 hp

	L SERIES				L STANDARD			
	60	80	100	120	60	80	100	120
Tractor power hp	50-100	60-110	70-120	95-140	50-80	60-110	70-120	95-140
Lift capacity at pivot* m	3,45	3,77	3,92	4,13	3,45	3,77	3,92	4,13
Lift capacity of pallet fork at ground level kg ⁽¹⁾	1770	1800	2350	2450	1410	1440	1880	1950
Lift capacity of pallet fork at 2m lift height 2 m ⁽¹⁾	1240	1430	1960	2280	990	1150	1570	1850
Lift capacity of pallet fork at maximum height kg ⁽¹⁾	1000	1100	1500	2030	800	880	1200	1650
Digging angle (at ground level)*	44°	49°	49°	51°	44°	49°	49°	51°
Dump angle (at full height)*	57,5°	53°	55°	54°	57,5°	53°	55°	54°
Lift cylinder OD (Ø mm)	Ø 65	Ø 70	Ø 75	Ø 80	Ø 65	Ø 70	Ø 75	Ø 80
Mechanical self-levelling	Yes	Yes	Yes	Yes	No	No	No	No
Mechanical self-levelling	Yes	Yes	Yes	Yes	Yes	Yes	Yes	Yes
Distance between boom arms mm	1020	1020	1020	1020	1020	1020	1020	1020
Mounting frame type	MM	MM	MM	MM	MM	MM	MM	MM
Implement holder pre-equipped for Manip'Pic	Optional	Optional	Optional	Optional	Optional	Optional	Optional	Optional
Boom weight without options kg	430	500	570	640	430	480	550	620

*Features may vary according to tractor model - ⁽¹⁾180 bar control pressure at 60 l/min flow rate, measured 900 mm ahead of pivot.



Landini

Landini[®]



Servizio Ricambi | Parts Department
42018 San Martino in Rio [RE] Italia | viale della Resistenza, 39
t. +39 0522 735511 | f. +39 0522 735526
parts@argotracors.com | www.argotracors.com



6615899A1 4/2018 ^{GB}
graphic design: **gruppo saldatori**
bzzbzz@grupposaldatori.com
All data and illustrations provided in this
brochure are for information purposes